

Monogram.

Use and Care Guide

for ZEK735

Built-In Wall Oven

Monogram.TM

27" Self-Cleaning Oven

164D3333P017

Introduction

Your new Monogram built-in oven makes an eloquent statement of style, convenience and kitchen planning flexibility. Whether you chose it for its purity of design or assiduous attention to detail, you'll find that your Monogram built-in oven's superior blend of form and function will delight you for years to come.

The ZEK735 Monogram built-in oven is designed to provide the flexibility to blend in with your kitchen cabinetry. Its sleek design can be beautifully integrated in the kitchen.

The information on the following pages will help you operate and maintain your built-in oven properly.

If you have any other questions—please call the GE Answer Center® 800.626.2000.

Contents

Aluminum Foil ...	16, 20, 23, 24–26	Problem Solver	32, 33
Appliance Registration	3	Thermostat Adjustment–	
Baking.....	14–16	<i>Do It Yourself</i>	19
Broiling	24	Roasting	20, 23
Broiling Guide	25	Roasting Guide	23
Care and Cleaning	29–31	Roasting with Probe.....	21, 22
Broiler Pan and Grid	29	Safety Instructions	4, 5
Oven Door	30	Self-Cleaning Instructions ...	26–28
Oven Light Replacement.....	29	Shelves.....	5, 13, 14, 20, 24–26, 28
Oven Shelves.....	30	Special Features	
Probe.....	31	of Your Control	10–12
Clock and Timer	9–11	Timed Baking	23, 24
Consumer Services	34	Warranty	35
Important Phone Numbers ...	34	Questions?	
Control Panel	8–12	Call GE Answer Center®	
Features.....	6, 7	800.626.2000	
Model and Serial Numbers	3		
Preheating	15, 23–25		

How to Remove Packaging Tape

To assure no damage is done to the finish of the product, the safest way to remove adhesive left from packaging tape on new appliances is an application of a household liquid dishwashing detergent, mineral oil or cooking oil. Apply with a soft cloth and allow to soak. Wipe dry and then apply an appliance polish to thoroughly clean and protect the surface.

NOTE: The plastic tape must be removed from the chrome trim on the oven parts. It cannot be removed if it is baked on.

Before using your oven, read this guide carefully.

It is intended to help you operate and maintain your new oven properly.

Keep it handy for answers to your questions.

If you don't understand something or need more help, call:

GE Answer Center®
800.626.2000
24 hours a day, 7 days a week

Write down the model and serial numbers.

You'll find them on a label on the front of the oven behind the oven door.

These numbers are also on the Consumer Product Ownership Registration Card that came with your oven. Before sending in this card, please write these numbers here:

Model Number

Serial Number

Use these numbers in any correspondence or service calls concerning your oven.

If you received a damaged oven...

Immediately contact the dealer (or builder) that sold you the oven.

Save time and money. Before you request service...

Check the Problem Solver in the back of this guide. It lists causes of minor operating problems that you can correct yourself.

If you need service...

To obtain service, see the Consumer Services page in the back of this guide.

We're proud of our service and want you to be pleased. If for some reason you are not happy with the service you receive, here are three steps to follow for further help.

FIRST, contact the people who serviced your appliance. Explain why you are not pleased. In most cases, this will solve the problem.

NEXT, if you are still not pleased, write all the details—including your phone number—to:

Manager, Consumer Relations
GE Appliances
Appliance Park
Louisville, KY 40225

FINALLY, if your problem is still not resolved, write:

Major Appliance Consumer
Action Program
20 North Wacker Drive
Chicago, IL 60606

IMPORTANT SAFETY INSTRUCTIONS

Read all instructions before using this appliance.

IMPORTANT SAFETY NOTICE

- **The California Safe Drinking Water and Toxic Enforcement Act** requires the Governor of California to publish a list of substances known to the state to cause birth defects or other reproductive harm, and requires businesses to warn customers of potential exposure to such substances.
- **The fiberglass insulation in self-cleaning ovens gives off a very small amount of carbon monoxide during the cleaning cycle.** Exposure can be minimized by venting with an open window or using a ventilation fan or hood.

When using electrical appliances, basic safety precautions should be followed, including the following:

- **Have the installer show you the location of the circuit breaker or fuse.** Mark it for easy reference.
- **Use this appliance only for its intended use** as described in this guide.
- **Be sure your appliance is properly installed and grounded** by a qualified technician in accordance with the provided installation instructions.
- **Do not attempt to repair or replace any part of your oven unless it is specifically recommended in this guide.** All other servicing should be referred to a qualified technician.
- **Before performing any service, DISCONNECT THE OVEN POWER SUPPLY AT THE HOUSEHOLD DISTRIBUTION PANEL BY REMOVING THE FUSE OR SWITCHING OFF THE CIRCUIT BREAKER.**
- **Do not leave children alone**—children should not be left alone or unattended in an area where an appliance is in use. They should never be allowed to sit or stand on any part of the appliance.
- **Do not allow anyone to climb, stand or hang on the door.** They could damage the oven or cause severe personal injury.
- **Be sure the oven is securely installed in a cabinet that is firmly attached to the house structure.** Never allow anyone to climb, sit, stand or hang on the oven door.

- **CAUTION: ITEMS OF INTEREST TO CHILDREN SHOULD NOT BE STORED IN CABINETS ABOVE AN OVEN. CHILDREN CLIMBING ON THE OVEN TO REACH ITEMS COULD BE SERIOUSLY INJURED.**

- **Teach children not to play with the controls** or any other part of the oven.
- **Never leave the oven door open** when you are not watching the oven.
- **Always keep combustible wall coverings, curtains or drapes a safe distance from your oven.**
- **Always keep dish towels, dish cloths, pot holders and other linens a safe distance from your oven.**
- **Always keep wooden and plastic utensils and canned food a safe distance away from your oven.**
- **Never wear loose-fitting or hanging garments while using the appliance.** Be careful when reaching for items stored in cabinets over the oven. Flammable material could be ignited if brought in contact with hot heating elements and may cause severe burns.



- **Use only dry pot holders**—moist or damp pot holders on hot surfaces may result in burns from steam. Do not let pot holders touch hot heating elements. Do not use a towel or other bulky cloth. Such cloths can catch fire on a hot heating element.
- **DO NOT STORE OR USE COMBUSTIBLE MATERIALS, GASOLINE OR OTHER FLAMMABLE VAPORS AND LIQUIDS IN THE VICINITY OF THIS OR ANY OTHER APPLIANCE.**

- **Do not let cooking grease or other flammable materials accumulate in or near the oven.**



- **Do not use water on grease fires.** Smother fire or flame or use a multi-purpose dry chemical or foam-type fire extinguisher.

Flame in the oven can be smothered completely by closing the oven door and turning the oven off or by using a multi-purpose dry chemical or foam-type fire extinguisher.

- **Never leave the oven door open when you are not watching the oven.**
- **Do not store flammable materials in an oven.**
- **For your safety, never use your appliance for warming or heating the room.**
- **Do not touch the heating elements or the interior surface of the oven.** These surfaces may be hot enough to burn even though they are dark in color. During and after use, do not touch, or let clothing or other flammable materials contact, any interior area of the oven; allow sufficient time for cooling first.

Potentially hot surfaces include the oven vent opening, surfaces near the opening, crevices around the oven door, the edges of the door window and metal trim parts above the door.

Remember: The inside surface of the oven may be hot when the door is opened.

- **When cooking pork,** follow the directions exactly and always cook the meat to an internal temperature of at least 170°F. This assures that, in the remote possibility that trichina may be present in the meat, it will be killed and the meat will be safe to eat.

Oven

- **Stand away from the oven when opening the door.** The hot air or steam which escapes can cause burns to hands, face and/or eyes.
- **Do not heat unopened food containers.** Pressure could build up and the container could burst, causing an injury.
- **Keep the oven vent ducts unobstructed.**
- **Keep the oven free from grease buildup.**
- **Place the oven shelf in the desired position while the oven is cool.** If the shelves must be handled when hot, do not let pot holders contact the heating elements.
- **Pulling out the shelf to the stop-lock is a convenience in lifting heavy foods.** It is also a precaution against burns from touching hot surfaces of the door or oven walls.

- **When using cooking or roasting bags in the oven,** follow the manufacturer's directions.
- **Do not use your oven to dry newspapers.** If overheated, they can catch on fire.
- **Do not use the oven for a storage area.** Items stored in an oven can ignite.
- **Do not leave paper products, cooking utensils or food in the oven when not in use.**
- **After broiling, always take the broiler pan out of the oven and clean it.** Leftover grease in the broiler pan can catch on fire next time you use the pan.
- **Never leave jars or cans of fat drippings in or near your oven.**
- **Do not use aluminum foil** to line the oven bottom, except as suggested in this guide. Improper installation of aluminum foil may result in a risk of electric shock or fire.
- **Clean only parts listed in this Use and Care Guide.**

Self-Cleaning Oven

- **Do not clean the oven door gasket.** The door gasket is essential for a good seal. Care should be taken not to rub, damage or move the gasket.
- **Do not use oven cleaners.** No commercial oven cleaner or oven liner protective coating of any kind should be used in or around any part of the oven. Residue from oven cleaners will damage the inside of the oven when the self-clean cycle is used.
- **Before self-cleaning the oven,** remove the broiler pan, grid and other cookware.
- **Be sure to wipe up excess spillage before starting the self-cleaning operation.**
- **If the self-cleaning mode malfunctions, turn the oven off and disconnect the power supply.** Have it serviced by a qualified technician.

**SAVE THESE
INSTRUCTIONS**

FEATURES OF YOUR OVEN

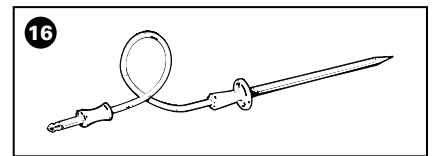
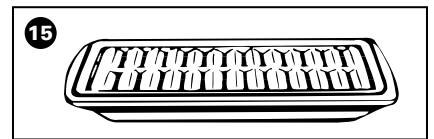
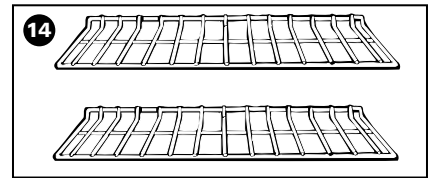
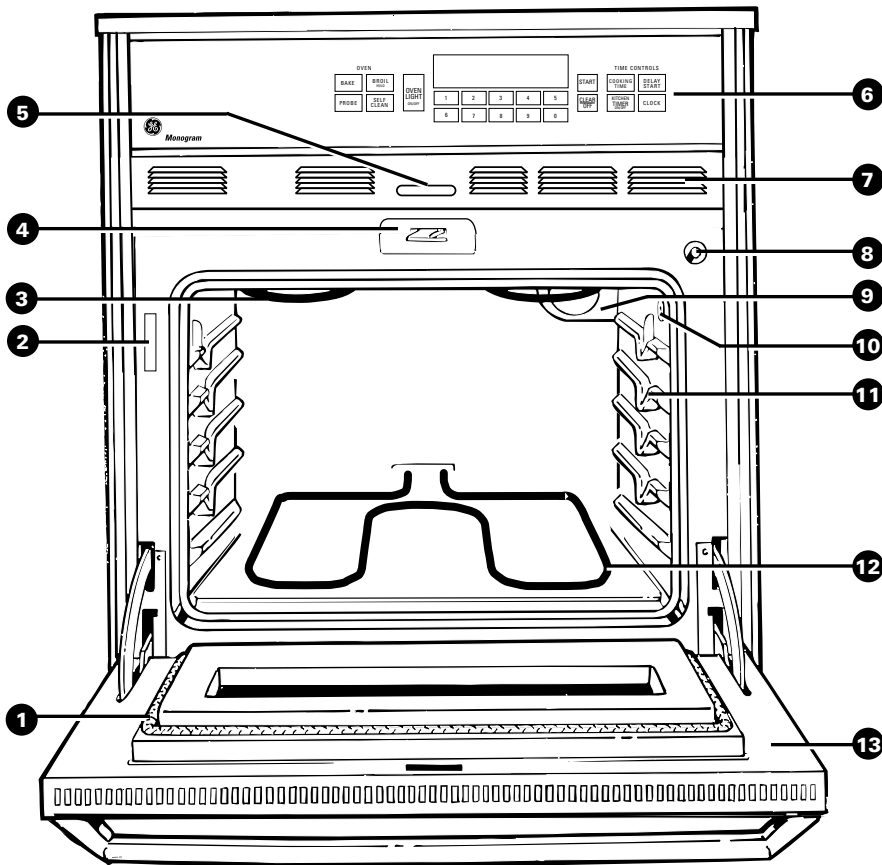

Feature Index	Explained on page
1 Oven Door Gasket	26, 30
2 Model and Serial Numbers	3
3 Oven Broil Element	5, 24, 25, 29
4 Automatic Oven Door Latch	26–28
5 Oven Vent	5
6 Oven Control, Clock and Timer	8–12
7 Oven Vent Grille	26
8 Automatic Oven Light Switch	—
9 Oven Interior Light	26, 29
10 Probe Outlet	21, 22
11 Oven Shelf Supports Shelf positions for cooking are suggested in the Baking, Roasting and Broiling sections.	5, 13, 14, 20, 24–26, 28, 30
12 Bake Element May be lifted gently for wiping the oven floor.	4, 29
13 Lift-Off Oven Door with Broil Stop Position Easily removed for cleaning.	30
14 Oven Shelves with Stop-Locks	5, 13, 14, 20, 24–26, 28, 30
15 Broiler Pan and Grid	5, 20, 21, 24–26, 29
16 Probe	21, 22, 31

FEATURES OF YOUR OVEN CONTROL

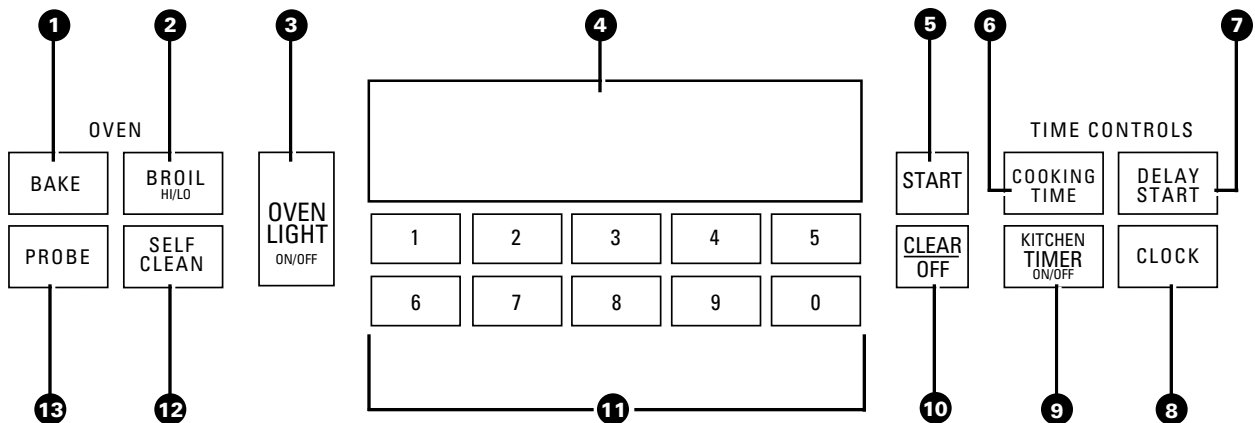

- 1. BAKE.** Press to select the bake function.
- 2. BROIL HI/LO.** Press to select the broil function.
- 3. OVEN LIGHT ON/OFF.** Press to turn the oven light on or off.
- 4. DISPLAY.** Shows the operations you have selected, the time of day and the cooking or cleaning status.
- 5. START.** Must be pressed to start any cooking or cleaning function.
- 6. COOKING TIME.** Use for Timed Bake.
- 7. DELAY START.** Use along with COOKING TIME or SELF CLEAN to set the oven to start and stop automatically at a time you select.
- 8. CLOCK.** Press to enter the time of day.
- 9. KITCHEN TIMER ON/OFF.** Press to select the timer function. The timer does not control oven operations. The timer can time up to 9 hours and 59 minutes.
- 10. CLEAR/OFF.** Press to cancel any timed oven operation except the clock and timer.
- 11. NUMBER PADS.** Use to set any function requiring numbers—for example, the time of day on the clock, the timer, the oven temperature, the internal food temperature, the starting and length of cooking time for Timed Bake and the starting and length of cleaning time for Self-Clean.
- 12. SELF CLEAN.** Press to select the self-cleaning function. See the Operating the Self-Cleaning Oven section.
- 13. PROBE.** Press when using the probe to cook food.

If “F—and a number or letter” flash in the display and the oven control signals, this indicates function error code. Press CLEAR/OFF. Allow the oven to cool for one hour. Put the oven back into operation. If the function error code repeats, disconnect power to the oven and call for service.

OVEN CONTROL, CLOCK AND TIMER

Clock

The clock must be set for the automatic oven timing functions to work properly.

The time of day clock **cannot** be changed during Delay Start. (It can be changed during a regular bake or broil operation.)

To Set the Clock



1. Press CLOCK.

2. Press the number pads the same way you read them. **For example**, to set 12:34, press the number pads 1, 2, 3 and 4 in that order.

If number pads are not pressed within one minute after you press CLOCK, the display reverts to the original setting. If this happens, press CLOCK and reenter the time of day.



3. Press START. This enters the time and starts the clock.

To check the time of day when the display is showing other information, simply press CLOCK. The time of day shows until another pad is pressed.

Timer

You may program the timer to time cooking or other household activities for up to 9 hours and 59 minutes.

The timer counts down in minutes, 1 minute at a time, until the last 60 seconds are reached, then the control will beep one time. The seconds will not be displayed until the last minute is reached.

When the timer reaches “:00,” the control will beep 3 times followed by one beep every 6 seconds until KITCHEN TIMER ON/OFF is pressed.

The 6 second tone can be canceled by following the steps in the Special Features of Your Oven Control section under Tones at the End of a Timed Cycle.

How to Set the Timer



1. Press KITCHEN TIMER ON/OFF.

2. Press the number pads to set the time. **For example**, to enter 2 hours and 45 minutes, touch 2, 4 and 5 in that order.

If you make a mistake, press KITCHEN TIMER ON/OFF and begin again.



3. Press START.

After pressing START, “SET” disappears; this tells you the time is counting down, although the display does not change until one minute has passed.



4. When time is up, the oven control signals until you press KITCHEN TIMER ON/OFF. Display then shows the time of day.

NOTE: The minute timer is independent of all the other functions and it does not control the oven. The CLEAR/OFF pad does not affect the timer.

Power Failure

If a **flashing time of day is in the display**, you have experienced a power failure. Reset the clock. **To reset the clock**, press CLOCK. Enter the correct time of day by pressing the appropriate number pads. Press START.

(continued next page)

OVEN CONTROL, CLOCK AND TIMER

(continued)

The control has a series of tones that will sound at different times. These tones may sound while you set the control for an oven function or at the end of the oven function. They will also alert you when an incorrect time or temperature has been entered or if there is a problem with the oven.

Tones While Setting the Control

When you press a touch pad you will hear a beep. This beep will let you know you have placed enough pressure on the pad to activate it.

Preheat Notification Tone

When you set an oven temperature the oven automatically starts to heat. When the temperature inside the oven reaches your set temperature a tone will sound to let you know to place the food in the oven.

Attention Tone

This tone will sound if you set an invalid function or try to set an additional function. The tone can be quickly identified by watching the display messages.

SPECIAL FEATURES OF YOUR OVEN CONTROL

Your new touch pad control has additional features that you may choose to use. The following are the features and how you may activate them. The special feature modes can only be activated while the display is showing the time of day clock.

They remain in the control's memory until the steps are repeated. When the display shows your choice press **START**. The special features will remain in memory after a power failure.

Tones at the End of a Timed Cycle

At the end of a timed cycle, 3 short beeps will sound followed by one beep every 6 seconds, until **CLEAR/OFF** is pressed. This continuous 6 second beep may be canceled.

To cancel the 6 second beep:

BAKE

BROIL
HI/LO

1. Press **BAKE** and **BROIL HI/LO** at the same time for 2 seconds until the display shows "SF."

KITCHEN
TIMER
ON/OFF

2. Press **KITCHEN TIMER ON/OFF**. The display shows "CON BEEP" (continuous beep). Press **KITCHEN TIMER ON/OFF** again. The display shows "BEEP." (This cancels the one beep every 6 seconds.)

START

3. Press **START**.

12 Hour Shut-Off

With this feature, should you forget and leave the oven on, the control will automatically turn off the oven after 12 hours during baking functions or after 3 hours during a broil function. If you wish to turn off this feature, follow the steps below.

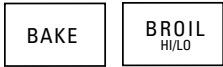

1. Press BAKE and BROIL HI/LO at the same time for 2 seconds until the display shows "SF."



2. Press DELAY START. The display will show "12 shdn" (12 hour shut-off). Press DELAY START again and the display will show "no shdn" (no shut-off).



3. Press START to activate the no shut-off and leave the control set in this special features mode.

Cook and Hold

Your new control has a cook and hold feature that keeps cooked foods warm for up to 3 hours after the cooking function is finished. To activate this feature, follow the steps below.



1. Press BAKE and BROIL HI/LO at the same time for 2 seconds until the display shows "SF."



2. Press COOKING TIME. The display will show "Hld OFF."

—Press COOKING TIME again to activate the feature. The display will show "Hld ON."



3. Press START to activate the cook and hold feature and leave the control set in this special features mode.

12 Hour, 24 Hour or Clock Black-Out

Your control is set to use a 12 hour clock. If you would prefer to have a 24 hour military time clock or black-out the clock display, follow the steps below.



1. Press BAKE and BROIL HI/LO at the same time for 2 seconds until the display shows "SF."



2. Press CLOCK once. The display will show "12 hr."

—Press CLOCK again to change to the 24 hour military time clock. The display will show "24 hr."

—Press CLOCK again to black-out the clock display. The display will show "OFF."



3. Press START to activate your choice and leave the control set in this special features mode.

NOTE: If the clock is in the black-out mode you will not be able to use the Delay Start function.

(continued next page)

SPECIAL FEATURES OF YOUR OVEN CONTROL

(continued)

Control Lockout

Your control will allow you to lock down the touch pads so they cannot be activated when pressed.



1. Press BAKE and BROIL HI/LO at the same time for 2 seconds until the display shows “SF.”



2. Press SELF CLEAN. The display will show “LOC OFF.”

—Press SELF CLEAN again. The display will show “LOC.”



3. Press START to activate the control lockout feature and leave the control set in this special features mode.

When this feature is on and the touch pads are pressed the control will beep and the display will show “LOC.”

NOTE: The control lockout mode will not affect the clock, timer and oven light touch pads.

Fahrenheit or Centigrade Temperature Selection

Your oven control is set to use the Fahrenheit temperature selections but you may change this to use the Centigrade selections.



1. Press BAKE and BROIL HI/LO at the same time for 2 seconds until the display shows “SF.”



2. Press BROIL HI/LO. The display will show “F” (Fahrenheit).



3. Press BROIL HI/LO again. The display will show “C” (Centigrade).



4. Press START.

USING YOUR OVEN

Before Using Your Oven

1. Look at the controls. Be sure you understand how to set them properly.
2. Check the inside of the oven. Look at the shelves. Take a practice run at removing and replacing them properly to give sure, sturdy support.
3. Read over the information and tips that follow.
4. Keep this guide handy so you can refer to it, especially during the first weeks of using your new oven.

NOTE:

- You may notice a “burning” or “oily” smell the first few times you turn your oven on. This is normal in a new oven and will disappear in a short time. To speed the process, set a self-clean cycle for 4 hours. See the Operating the Self-Cleaning Oven section.
- A cooling fan may automatically turn on and off to cool internal parts. This is normal, and the fan may continue to run even after the oven is turned off.

Oven Shelves

The shelves are designed with stop-locks so that, when placed correctly on the shelf supports, they will stop before coming completely out of the oven, and will not tilt when removing food from or placing food on them.

When placing cookware on a shelf, pull the shelf out to the bump on the shelf support. Place the cookware on the shelf, then slide the shelf back into the oven. This will eliminate reaching into the hot oven.

To remove the shelf from the oven, pull the shelf toward you, tilt the front end upward and pull the shelf out.

To replace, place the shelf on the shelf support with the stop-locks (curved extension of the shelf) facing up and toward the rear of the oven. Tilt up the front and push the shelf toward the back of the oven until it goes past the bump on the shelf support. Then lower the front of the shelf and push it all the way back.

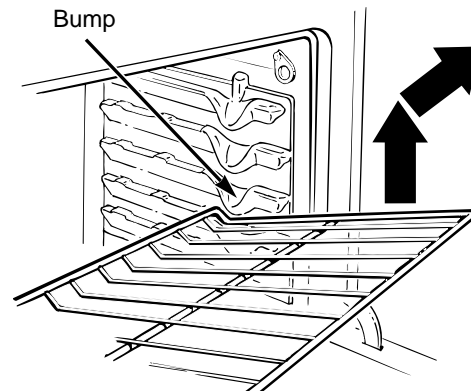

Shelf Positions

The oven has four shelf supports identified in this illustration as A (bottom), B, C, and D (top).

See the Baking section for shelf placement suggestions.

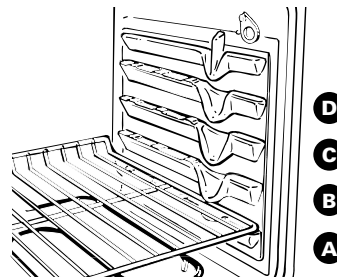

BAKING

Your oven temperature is controlled very accurately using an oven control system. It is recommended that you operate the oven for a number of weeks to become familiar with your new oven's performance. If you think an adjustment is necessary, see the Adjust the Oven Thermostat section. It lists easy *Do It Yourself* instructions on how to adjust the thermostat.

How to Set Your Oven for Baking

To avoid possible burns, place shelves in the correct position before you turn the oven on.

BAKE

1. Press BAKE.

2. Press the number pads to set the oven temperature.

START

3. Press START. When the oven starts to heat the changing temperature will be in the display. (The display starts changing once the temperature reaches 100°F.)

CLEAR
OFF

4. Press CLEAR/OFF when baking is finished.

NOTE:

- A cooling fan may automatically turn on and off to cool internal parts. This is normal, and the fan may continue to run even after the oven is turned off.

To change the oven temperature during the Bake cycle, press BAKE and set the new temperature.

Oven Shelves

Arrange the oven shelf or shelves in the desired locations while the oven is cool. The correct shelf position depends on the kind of food and the browning desired. As a general rule, place most foods in the middle of the oven, on either shelf position B or C. See the chart for suggested shelf positions.

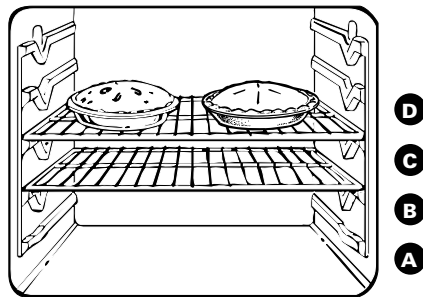

Type of Food	Shelf Position
Angel food cake	A
Biscuits or muffins	B or C
Cookies or cupcakes	B or C
Brownies	B or C
Layer cakes	B or C
Bundt or pound cakes	A or B
Pies or pie shells	B or C
Frozen pies	A (on cookie sheet)
Casseroles	B or C
Roasting	A or B

Preheating

Preheat the oven if the recipe calls for it. Preheat means bringing the oven up to the specified temperature before putting the food in the oven. To preheat, set the oven at the correct temperature—selecting a higher temperature does not shorten preheat time.

Preheating is necessary for good results when baking cakes, cookies, pastry and breads. For most casseroles and roasts, preheating is not necessary. For ovens without a preheat indicator light or tone, preheat 10 minutes. After the oven is preheated, place the food in the oven as quickly as possible to prevent heat from escaping.

Baking Pans

Use the proper baking pan. The type of finish on the pan determines the amount of browning that will occur.

- Dark, rough or dull pans absorb heat resulting in a browner, crisper crust. Use this type for pies.
- Shiny, bright and smooth pans reflect heat, resulting in a lighter, more delicate browning. Cakes and cookies require this type of pan.
- Glass baking dishes also absorb heat. When baking in glass baking dishes, the temperature may need to be reduced by 25°F.
- If you are using dark non-stick pans, you may find that you need to reduce the oven temperature 25°F. to prevent over-browning.

Pan Placement

For even cooking and proper browning, there must be enough room for air circulation in the oven. Baking results will be better if baking pans are centered as much as possible rather than being placed to the front or to the back of the oven.

Pans should not touch each other or the walls of the oven. Allow 1- to 1½-inch space between pans as well as from the back of the oven, the door and the sides. If you need to use two shelves, stagger the pans so one is not directly above the other.

Cookies

When baking cookies, flat cookie sheets (without sides) produce better-looking cookies. Cookies baked in a jelly roll pan (short sides all around) may have darker edges and pale or light browning may occur.

Do not use a cookie sheet so large that it touches the walls or the door of the oven. Never entirely cover a shelf with a large cookie sheet.

For best results during baking, use only one cookie sheet in the oven at a time.

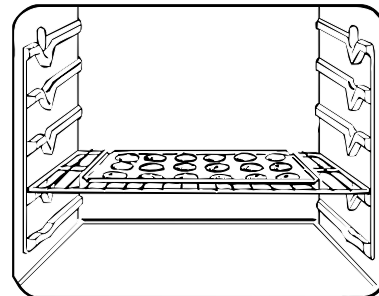

(continued next page)

BAKING

(continued)

Pies

For best results, bake pies in dark, rough or dull pans to produce a browner, crisper crust. Frozen pies in foil pans should be placed on an aluminum cookie sheet for baking since the shiny foil pan reflects heat away from the pie crust; the cookie sheet helps retain it.

Cakes

When baking cakes, warped or bent pans will cause uneven baking results and poorly shaped products. A cake baked in a pan larger than the recipe recommends will usually be crisper, thinner and drier than it should be. If baked in a pan smaller than recommended, it may be undercooked and batter may overflow. Check the recipe to make sure the pan size used is the one recommended.

Aluminum Foil

Never entirely cover a shelf with aluminum foil. This will disturb the heat circulation and result in poor baking. A smaller sheet of foil may be used to catch a spillover by placing it on a lower shelf several inches below the food.

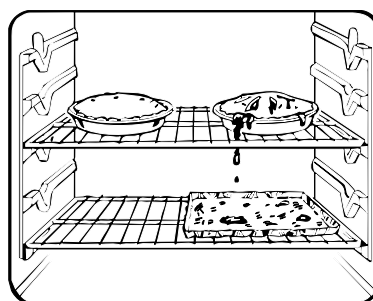

Don't Peek

Set the timer for the estimated cooking time and do not open the door to look at your food. Most recipes provide minimum and maximum baking times such as “bake 30-40 minutes.”

DO NOT open the door to check until the minimum time. Opening the oven door frequently during cooking allows heat to escape and makes baking times longer. Your baking results may also be affected.

TIMED BAKING

How to Set Your Oven for Time Bake

The oven control allows you to turn the oven on or off automatically at specific times that you set. Examples of Immediate Start (oven turns on now and you set it to turn off automatically at the end of cooking time) and Delay Start and Stop (setting the oven to turn on automatically at a later time and turn off after a preset cooking time) will be described.

NOTE: Before beginning make sure the clock shows the correct time of day.

CLOCK

To set the clock, first press CLOCK. Press the number pads to set the time of day. Press START.

NOTE: An attention tone will sound if you are using Timed Baking and do not press START after entering the baking temperature.

How to Set Immediate Start and Automatic Stop

To avoid possible burns, place the shelves in the correct position before you turn the oven on.

The oven will turn on immediately and cook for a selected length of time. At the end of cooking time, the oven will turn off automatically.

BAKE

1. Press BAKE.

2. Press the number pads to set the oven temperature.

3. Press COOKING TIME.

COOKING TIME

NOTE: If your recipe requires preheating, you may need to add additional time to the length of the cooking time.

4. Press the number pads to set the baking time.

The oven temperature and the cooking time that you entered will be displayed.

START

5. Press START. The display shows the oven temperature that you set and the cooking time countdown. (The display starts changing once the temperature reaches 100°F.)

The oven will continue to cook for the programmed amount of time, then shut off automatically.

CLEAR OFF

6. Press CLEAR/OFF to clear the end of cycle tone if necessary.

NOTE:

- The low temperature zone of this oven (between 170°F. and 200°F.) is available to keep hot cooked foods warm. Food kept in the oven longer than two hours at these low temperatures may spoil.
- Foods that spoil easily, such as milk, eggs, fish, stuffings, poultry and pork, should not be allowed to sit for more than one hour before or after cooking. Room temperature promotes the growth of harmful bacteria. Be sure the oven light is off because heat from the bulb will speed harmful bacteria growth.

(continued next page)

TIMED BAKING

(continued)

How to Set Delay Start and Automatic Stop

Easy Steps:

1. Press BAKE.
2. Press the number pads to select oven temperature.
3. Press COOKING TIME.
4. Press the number pads to set the length of baking time.
5. Press DELAY START.
6. Press the number pads to set the desired start time.
7. Press START.

To avoid possible burns, place the shelves in the correct position before you turn the oven on.

You can set the control to delay the start of cooking, cook for a specific length of time and then turn off automatically.

BAKE

1. Press BAKE.

2. Press the number pads to set the temperature.

COOKING
TIME

3. Press COOKING TIME.

NOTE: If your recipe requires preheating, you may need to add additional time to the cooking time.

4. Press the number pads to set the baking time.

DELAY
START

5. Press DELAY START.

6. Press the number pads to set the time of day you want the oven to turn on and start cooking.

START

7. Press START.

DELAY
START

If you would like to check the times you have set, press DELAY START to check the start time you have set or press COOKING TIME to check the length of cooking time you have set.

When the oven turns on at the time of day you have set, the display will show the changing temperature (starting at 100°F.) and the cooking time countdown.

At the end of cooking time the oven will turn off and the end of cycle tone will sound.

CLEAR
OFF

8. Press CLEAR/OFF to clear the end of cycle tone if necessary.

NOTE:

- The low temperature zone of this oven (between 170°F. and 200°F.) is available to keep hot cooked foods warm. Food kept in the oven longer than two hours at these low temperatures may spoil.
- Foods that spoil easily, such as milk, eggs, fish, stuffings, poultry and pork, should not be allowed to sit for more than one hour before or after cooking. Room temperature promotes the growth of harmful bacteria. Be sure the oven light is off because heat from the bulb will speed harmful bacteria growth.

ADJUST THE OVEN THERMOSTAT— *DO IT YOURSELF!*

You may find that your new oven cooks differently than the one it replaced. We recommend that you use your new oven for a few weeks to become more familiar with it, following the times given in your recipes as a guide.

If you think your new oven is too hot or too cool, you can adjust the thermostat yourself. If you think it is too hot, adjust the thermostat to make it cooler. If you think it is too cool, adjust the thermostat to make it hotter.

We do not recommend the use of inexpensive thermometers, such as those found in grocery stores, to check the temperature setting of your new oven. These thermometers may vary 20–40 degrees.

To Adjust the Thermostat:



1. Press BAKE and BROIL HI/LO at the same time for 2 seconds until the display shows “SF.”
2. Press BAKE. A two digit number shows in the display. Press BAKE once to increase (+) the oven temperature, or twice to decrease (-).
3. The oven temperature can be adjusted up to (+) 35°F. hotter or (-) 35°F. cooler. Press the number pads the same way you read them. **For example,** to change the oven temperature 15°F, press 1 and 5.
4. When you have made the adjustment, press START to go back to the time of day display. Use your oven as you would normally.

NOTE: This adjustment will not affect the broiling or self-cleaning temperatures. It will be retained in memory after a power failure.

ROASTING

Roasting is cooking by dry heat. Tender meat or poultry can be roasted uncovered in your oven. Roasting temperatures, which should be low and steady, keep spattering to a minimum.

Roasting is really a baking procedure used for meats. Therefore, oven controls are set for Baking or Timed Baking. (You may hear a slight clicking sound, indicating the oven is working properly.) Timed Baking will turn the oven on and off automatically.

Most meats continue to cook slightly after being removed from the oven. The internal temperature will rise about 5° to 10°F. during the recommended standing time of 10 to 20 minutes. This allows roasts to firm up and makes them easier to carve. To compensate for this rise in temperature, you may want to remove the roast sooner (at 5° to 10°F. less than the temperature in the Roasting Guide).

Remember that food will continue to cook in the hot oven and therefore should be removed when the desired internal temperature has been reached.

How to Set Your Oven for Roasting

1. Place the shelf in A or B position. No preheating is necessary.

2. Check the weight of the meat. Place the meat fat side up, or poultry breast side up, on roasting grid in a shallow pan. The melting fat will baste the meat. Select a pan as close to the size of the meat as possible. (The broiler pan with grid is a good pan for this.)

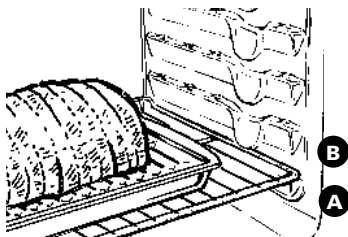

BAKE

3. Press BAKE.

START

4. Press the number pads to set the oven temperature.

5. Press START.

CLEAR
OFF

6. Press CLEAR/OFF when roasting is finished.

To change the oven temperature during the roasting cycle, press BAKE and set the new temperature.

Use of Aluminum Foil

You can use aluminum foil to line the broiler pan. This makes clean-up easier when using the pan for marinating, cooking with fruits, cooking heavily cured meats or basting food during cooking. Press the foil tightly around the inside of the pan.



ROASTING WITH THE PROBE

See the Roasting Guide.

Correct Placement of the Temperature Probe

A temperature probe has been provided for use in your new oven. This probe is designed to withstand high temperatures. Temperature probes provided with other products, such as those used for microwave ovens, may not be designed to withstand high temperatures. Use of probes other than the one provided with this product may result in damage to the probe.

Never leave your probe inside the oven during a self-cleaning cycle.

For many foods, especially roasts and poultry, internal food temperature is the best test for doneness. The temperature probe takes the guesswork out of roasting by cooking foods to the exact doneness you want. When the internal temperature of the food reaches the temperature you set, the oven automatically shuts off.

The temperature probe has a skewer-like probe at one end and a plug at the other end that goes into the outlet in the oven.

Use the handles of the probe and plug when inserting and removing them from the meat and the outlet in the oven. Do not use tongs to pull on the cable when removing the probe—they might damage it. **TO AVOID BREAKING THE PROBE, MAKE SURE FOOD IS COMPLETELY DEFROSTED BEFORE INSERTING.**

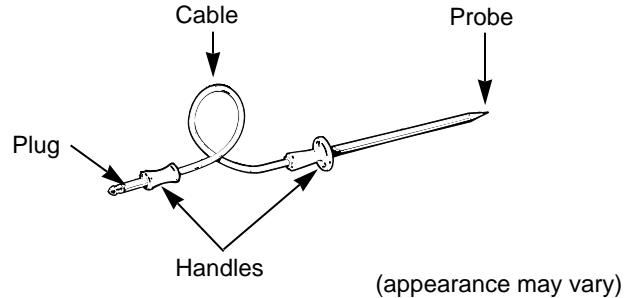

After preparing the meat and placing it on a trivet or on the broiler pan grid, follow these directions for proper probe placement.

1. Lay the probe on the outside of the meat along the top or side and mark with your finger where the edge of the meat comes to on the probe. The point should rest in the center of the thickest meaty part of the roast.

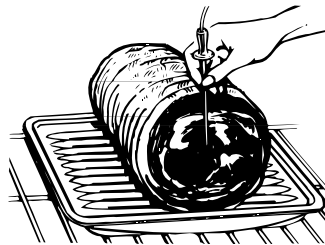

2. Insert the probe into the meat up to the point marked off with your finger. It should not touch the bone, fat or gristle.

No more than 2 inches of the probe, not counting the handle, should be left exposed outside the meat.

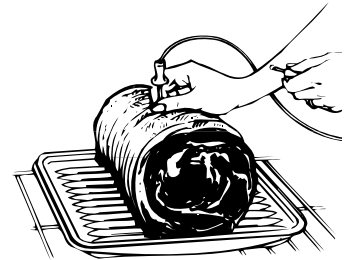

Ham or Lamb

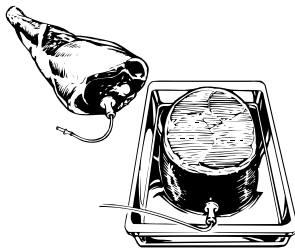

For roasts with no bone, insert the probe into the meatiest part of the roast. For bone-in ham or lamb, insert the probe into the center of the lowest large muscle or joint.

Casseroles or Fish

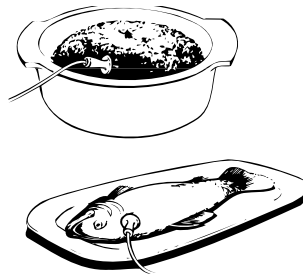

Insert the probe into the center of dishes such as meat loaf or casseroles. When cooking fish, insert the probe from just above the gill into the meatiest area, parallel to the backbone.

Poultry

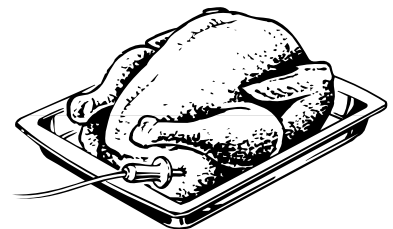

Insert the probe into the meatiest part of the inner thigh from below and parallel to the leg of a whole turkey.

(continued next page)

ROASTING WITH THE PROBE

(continued)

How to Set the Oven When Using the Temperature Probe

The display will flash if the probe is inserted into the outlet and you have not set a probe temperature and pressed START.

1. Insert the probe into the meat.
2. Plug the probe into the outlet in the oven. Make sure it's pushed all the way in. Close the oven door.

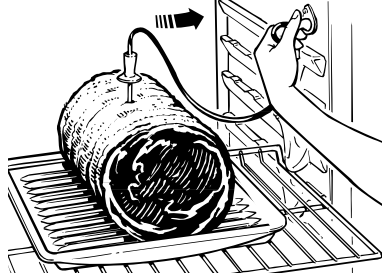

PROBE

3. Press PROBE.

4. Press the number pads to set the internal meat temperature.

BAKE

5. Press BAKE.

6. Press the number pads to set the oven temperature.

START

7. Press START.

The word "LO" will be in the display. After the internal temperature of the meat reaches 100°F, the changing internal temperature will be shown in the display.

CLEAR
OFF

8. When the internal temperature of the meat reaches the temperature you have set, the probe and the oven turn off and the oven control signals. To stop the signal, press CLEAR/OFF. Use hot pads to remove the probe from the food. Do not use tongs to pull on it—they might damage it.

CAUTION: To prevent possible burns, do not unplug the probe from the outlet until the oven has cooled. Do not store the probe in the oven.

NOTE: You can use the timer even though you cannot use timed oven operations.

To change the oven temperature during the roasting cycle, press BAKE and set the new temperature.

Roasting Questions and Answers

Q. Is it necessary to check for doneness with a meat thermometer?

A. Checking the finished internal temperature at the completion of cooking time is recommended if you did not use the probe while cooking. Temperatures are shown in the Roasting Guide. For roasts over 8 lbs., check with thermometer at half-hour intervals after half the cooking time has passed.

Q. Why is my roast crumbling when I try to carve it?

A. Roasts are easier to slice if allowed to cool 10 to 20 minutes after removing them from the oven. Be sure to cut across the grain of the meat.

Q. Do I need to preheat my oven each time I cook a roast or poultry?

A. It is not necessary to preheat your oven.

Q. When buying a roast, are there any special tips that would help me cook it more evenly?

A. Yes. Buy a roast as even in thickness as possible, or buy rolled roasts.

Q. Can I seal the sides of my foil “tent” when roasting a turkey?

A. Sealing the foil will steam the meat. Leaving it unsealed allows the air to circulate and brown the meat.

ROASTING GUIDE

Frozen Roasts

Frozen roasts of beef, pork, lamb, etc., can be started without thawing, but allow 10 to 25 minutes per pound additional time (10 minutes per pound for roasts under 5 pounds, more time for larger roasts).

Make sure poultry is thawed before roasting. Unthawed poultry often does not cook evenly. Some commercial frozen poultry can be cooked successfully without thawing. Follow the directions given on the package label.

Type	Oven Temperature	Doneness	Approximate Roasting Time in Minutes per Pound		Internal Temperature °F.
Meat			3 to 5 lbs.	6 to 8 lbs.	
Tender cuts; rib, high quality sirloin tip, rump or top round*	325°	Rare: Medium: Well Done:	24–33 35–39 40–45	18–22 22–29 30–35	140°–150°† 150°–160° 170°–185°
Lamb leg or bone-in shoulder*	325°	Rare: Medium: Well Done:	21–25 25–30 30–35	20–23 24–28 28–33	140°–150°† 150°–160° 170°–185°
Veal shoulder, leg or loin*	325°	Well Done:	35–45	30–40	170°–180°
Pork loin, rib or shoulder*	325°	Well Done:	35–45	30–40	170°–180°
Ham, precooked	325°	To Warm:	17–20 minutes per pound (any weight)		115°–125°
Poultry			3 to 5 lbs.	Over 5 lbs.	
Chicken or Duck	325°	Well Done:	35–40	30–35	185°–190°
Chicken pieces	350°	Well Done:	35–40		185°–190°
Turkey	325°	Well Done:	10 to 15 lbs. 18–25	Over 15 lbs. 15–20	In thigh: 185°–190°

*For boneless rolled roasts over 6 inches thick, add 5 to 10 minutes per pound to times given above.

†The U. S. Department of Agriculture says “Rare beef is popular, but you should know that cooking it to only 140°F. means some food poisoning organisms may survive.” (Source: *Safe Food Book. Your Kitchen Guide.* USDA Rev. June 1985.)

BROILING

Broiling is cooking food by intense radiant heat from the upper broil element in the oven. Most fish and tender cuts of meat can be broiled. Follow these directions to keep spattering and smoking to a minimum.

If the meat has fat or gristle around the edge, cut vertical slashes through both about 2 inches apart. If desired, the fat may be trimmed, leaving a layer about 1/8 inch thick.

Place the meat on the broiler grid in the broiler pan. Always use the grid so the fat drips into the broiler pan; otherwise the juices may become hot enough to catch on fire.

Position a shelf on recommended shelf position as suggested in the Broiling Guide. Most broiling is done on C position, **but if your oven is connected to 208 volts, you may wish to use a higher position.**

Leave the door open to the broil stop position. The door stays open by itself, yet the proper temperature is maintained in the oven.

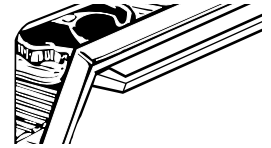

Turn the food using tongs only once during broiling. Time the foods for the first side according to the Broiling Guide.

Turn the food, then use the times given for the second side as a guide to the preferred doneness.

NOTE: Broil will not work if the temperature probe is plugged in.

How to Set Your Oven for Broiling



1. Press BROIL HI/LO.
2. Press BROIL HI/LO again (alternates between LO Broil and HI Broil).



3. Press START.



4. Press CLEAR/OFF when broiling is finished.

Use of Aluminum Foil

You can use aluminum foil to line your broiler pan and broiler grid. However, you must mold the foil tightly to the grid and cut slits in it just like the grid. Without the slits, the foil will prevent fat and meat juices from draining into the broiler pan. The juices could become hot enough to catch on fire. If you do not cut the slits, you are frying, not broiling.

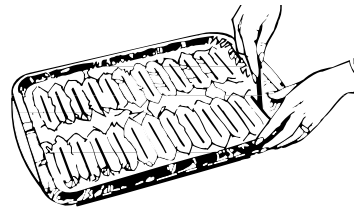

Questions and Answers

Q. Why are my meats not turning out as brown as they should?

- A.** In some areas, the power (voltage) to the oven may be low. In these cases, preheat the broil element for 10 minutes before placing the broiler pan with food in the oven. Check to see if you are using the recommended shelf position. Broil for the longest period of time indicated in the Broiling Guide. Turn the food only once during broiling. You may need to move the food to a higher shelf position.

Q. When broiling, is it necessary to always use a grid in the pan?

- A.** Yes. Using the grid suspends the meat over the pan. As the meat cooks, the juices fall into the pan, thus keeping meat drier. Juices are protected by the grid and stay cooler, thus preventing excessive spatter and smoking.

Q. Should I salt the meat before broiling?

- A.** No. Salt draws out the juices and allows them to evaporate. Always salt after cooking. Piercing meat with a fork also allows juices to escape. Turn the meat with tongs instead of a fork.

BROILING GUIDE

- Always use the broiler pan and grid that comes with your oven. It is designed to minimize smoking and spattering by trapping juices in the shielded lower part of the pan.
- **The oven door should be open to the broil stop position.**
- For steaks and chops, slash fat evenly around the outside edges of the meat. To slash, cut crosswise through the outer fat surface just to the edge of the meat. Use tongs to turn meat over to prevent piercing the meat and losing juices.
- If desired, marinate meats or chicken before broiling, or brush with barbecue sauce last 5 to 10 minutes only.
- When arranging food on the pan, do not let fatty edges hang over the sides because the dripping fat will soil the oven.
- The broiler does not need to be preheated. However, for very thin foods, or to increase browning, preheat if desired.
- Use LO Broil to cook foods such as poultry or thick pork chops thoroughly without over-browning them.
- Frozen steaks can be broiled by positioning the oven shelf at next lowest shelf position and increasing cooking time given in this guide 1½ times per side.
- **If your oven is connected to 208 volts, rare steaks may be broiled by preheating the broiler and positioning the oven shelf one position higher.**

Food	Quantity and/or Thickness	Shelf Position	First Side Time, Minutes	Second Side Time, Minutes	Comments
Bacon	1/2 lb. (about 8 thin slices)	C	4½	4½	Arrange in single layer.
Ground Beef Well Done	1 lb. (4 patties) 1/2 to 3/4 inch thick	C	10	7	Space evenly. Up to 8 patties take about same time.
Beef Steaks					
Rare	1 inch thick	C	6	5	Steaks less than 1 inch thick cook through before browning. Pan frying is recommended.
Medium	(1 to 1½ lbs.)	C	8	6	
Well Done		C	12	11	
Rare	1½ inches thick	C	10	7-8	Slash fat.
Medium	(2 to 2½ lbs.)	C	15	14-16	
Well Done		C	25	20-25	
Chicken	1 whole (2 to 2½ lbs.), split lengthwise	A	35	10-15	Reduce time about 5 to 10 minutes per side for cut-up chicken. Brush each side with melted butter. Broil skin-side-down first.
Bakery Products					
Bread (Toast) or Toaster Pastries	2 to 4 slices	C or D	1½-2	1/2	Space evenly. Place English muffins cut-side-up and brush with butter, if desired.
English Muffins	1 pkg. (2) 2 (split)	C or D	3-4		
Lobster Tails	2-4 (6 to 8 oz. each)	B	13-16	Do not turn over.	Cut through back of shell. Spread open. Brush with melted butter before broiling and after half of broiling time.
Fish	1-lb. fillets 1/4 to 1/2 inch thick	C	5	5	Handle and turn very carefully. Brush with lemon butter before and during cooking, if desired. Preheat broiler to increase browning.
Ham Slices (precooked)	1 inch thick	B	8	8	Increase time 5 to 10 minutes per side for 1½ inch thick or home cured ham.
Pork Chops Well Done	2 (1/2 inch thick) 2 (1 inch thick), about 1 lb.	C B	10 13	10 13	Slash fat.
Lamb Chops					
Medium Well Done	2 (1 inch thick), about 10 to 12 oz.	C C	10 12	9 10	Slash fat.
Medium Well Done	2 (1½ inches thick), about 1 lb.	C B	14 17	12 12-14	
Wieners and similar precooked sausages, bratwurst	1-lb. pkg. (10)	C	6	1-2	If desired, split sausages in half lengthwise; cut into 5- to 6-inch pieces.

OPERATING THE SELF-CLEANING OVEN

Normal Cleaning Time: 4 hours

Before a Clean Cycle

1. Remove the probe, broiler pan, broiler grid, all cookware and any aluminum foil from the oven—they can't withstand the high cleaning temperatures.

NOTE: The oven shelves may be cleaned in the self-cleaning oven. However, they will darken, lose their luster and become hard to slide. Wipe the shelf supports with cooking oil after self-cleaning to make shelves slide more easily.

2. Wipe up heavy soil on the oven bottom. If you use soap, rinse thoroughly before self-cleaning to prevent staining.

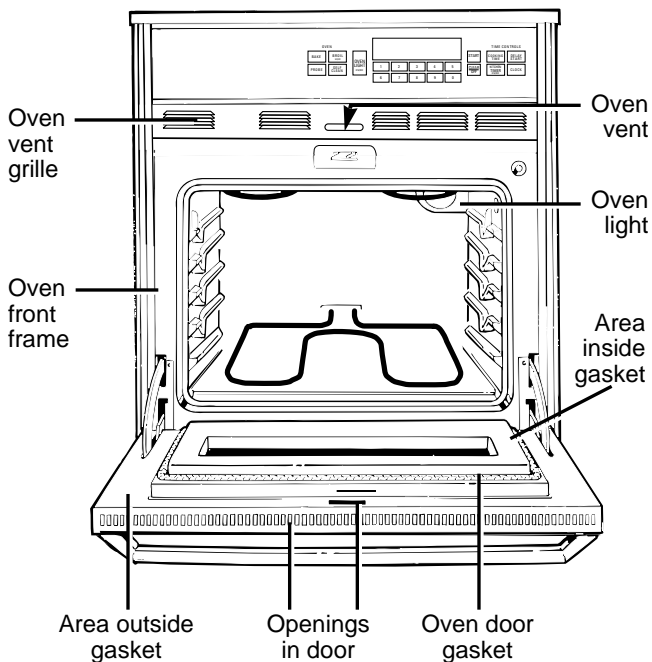

3. Clean spatters or soil on the oven front frame and the oven door **outside the gasket** with a dampened cloth. The oven front frame and the oven door outside the gasket do not get cleaned by the self-clean cycle. On these areas, use detergent and hot water or a soap-filled steel wool pad. Rinse well with a vinegar and water solution. This will help prevent a brown residue from forming when the oven is heated. Buff these areas with a dry cloth. Do not clean the gasket. Never use a commercial oven cleaner in or around the self-cleaning oven. Clean the outside front of the oven door with soap and water. Also use soap and water to clean under the oven vent grille. **Do not use abrasives or oven cleaners.**

Make sure the oven light bulb cover is in place.

Do not rub or clean the door gasket—the fiberglass material of the gasket has an extremely low resistance to abrasion. An intact and well-fitting oven door gasket is essential for energy-efficient oven operation and good baking results. If you notice the gasket becoming worn, frayed or damaged in any way or if it has become displaced on the door, you should have it replaced.

Do not let water run down through openings in the top of the door. To help prevent water from getting in these slots when cleaning, open the door as far as it will go.

4. Close the oven door and make sure the oven light is off. If the oven light is not turned off, the life of the bulb will be shortened or it may burn out immediately. The door latches automatically after the clean cycle is set.

Do not use commercial oven cleaners or oven protectors in or near the self-cleaning oven.

A combination of any of these products plus the high clean-cycle temperature may damage the porcelain finish of the oven.

Important

The oven door must be closed and all controls must be set correctly for the cycle to work properly.

How to Set Oven for Cleaning

Easy Steps:

1. Press SELF CLEAN.
2. Press the number pads to set the clean time.
3. Press START.

START

4. Press START.

The door locks automatically. The display will show the clean time remaining. It will not be possible to open the oven door until the temperature drops below the lock temperature and the LOCKED DOOR light goes off.

5. When the LOCKED DOOR light is off, open the door.

1. Follow the steps in the Before a Clean Cycle section.

SELF
CLEAN

2. Press SELF CLEAN.

3. Press the number pads to set the clean time, if a time other than 4 hours is needed.

Clean time is normally 4 hours. You can change the clean time to any time between 3 to 5 hours, depending on the amount of soil in your oven.

NOTE:

DELAY
START

- You can find out when the clean cycle will start by pressing DELAY START.
- The display will flash and the control will beep if you set the clean cycle and forget to close the oven door.

How to Set Delay Start of Cleaning

Easy Steps:

1. Press SELF CLEAN.
2. Press the number pads to set the clean time.
3. Press DELAY START.
4. Press the number pads to set the start time.
5. Press START.

DELAY
START

4. Press DELAY START.

5. Press the number pads to set the time of day you want the clean cycle to start.

6. Press START.

The door locks automatically. The display will show the start time. It will not be possible to open the oven door until the temperature drops below the lock temperature and the LOCKED DOOR light goes off.

7. When the LOCKED DOOR light is off, open the door.

Delay Start is setting the oven to start the clean cycle automatically at a later time than the present time of day.

NOTE: Before beginning, make sure the oven clock shows the correct time of day.

1. Follow the steps in the Before a Clean Cycle section.

SELF
CLEAN

2. Press SELF CLEAN.

3. Press the number pads to set the clean time.

(continued next page)

OPERATING THE SELF-CLEANING OVEN

(continued)

To Stop a Clean Cycle



1. Press CLEAR/OFF.

2. When the oven has cooled below the locking temperature and the LOCKED DOOR light goes off, open the door.

After Self-Cleaning

You may notice some white ash in the oven. Just wipe it up with a damp cloth after the oven cools.

If white spots remain, remove them with a soap-filled steel wool pad. Be sure to rinse thoroughly with a vinegar and water mixture. These deposits are usually a salt residue that cannot be removed by the clean cycle.

If the oven is not clean after one clean cycle, repeat the cycle.

NOTE:

- No functions can be programmed before the door automatically unlocks.
 - If the shelves have become hard to slide, wipe the shelf supports with cooking oil.
-

Questions and Answers

Q. If my oven clock is not set to the correct time of day, can I still self-clean my oven?

A. If the clock is not set to the correct time of day you will not be able to set a delay clean to end at a specific time.

Q. Can I use commercial oven cleaners on any part of my self-cleaning oven?

A. No cleaners or coatings should be used around any part of this oven. If you do use them and do not thoroughly rinse the oven with water, wiping it absolutely clean afterward, the residue can scar the oven surface and damage metal parts the next time the oven is automatically cleaned.

Q. What should I do if excessive smoking occurs during cleaning?

A. This is caused by excessive soil. Turn the oven off. Open the windows to rid the room of smoke. Wait until the oven has cooled and the words "LOCKED DOOR" are off in the display. Wipe up the excess soil and reset the clean cycle.

Q. Is the "crackling" or "popping" sound I hear during cleaning normal?

A. Yes. This is the sound of the metal heating and cooling during both the cooking and cleaning functions.

Q. Should there be any odor during the cleaning?

A. Yes, there will be an odor during the first few cleanings. Failure to wipe out excessive soil might also cause a strong odor when cleaning.

Q. What causes the hair-like lines on the enameled surface of my oven?

A. This is a normal condition, resulting from heating and cooling during cleaning. These lines do not affect how your oven performs.

Q. Why do I have ash left in my oven after cleaning?

A. Some types of soil will leave a deposit which is ash. It can be removed with a damp sponge or cloth.

Q. My oven shelves do not slide easily. What is the matter?

A. After many cleanings, the oven shelves will lose their luster and become hard to slide. To make the shelves slide more easily, wipe the shelf supports with cooking oil.

Q. My oven shelves have become gray after the self-clean cycle. Is this normal?

A. Yes. After the self-clean cycle, the shelves will lose some luster and discolor to a deep gray color.

CARE AND CLEANING

Proper care and cleaning are important so your oven will give you efficient and satisfactory service. Follow these directions carefully in caring for your oven to assure safe and proper maintenance.

BE SURE ELECTRICAL POWER IS OFF AND ALL SURFACES ARE COOL BEFORE CLEANING ANY PART OF THE OVEN.

Broiler Pan and Grid

After broiling, remove the broiler pan and grid from the oven. Remove the grid from the pan. Carefully pour the grease from the pan into a proper container. Wash and rinse the broiler pan and grid in hot water with a soap-filled or plastic scouring pad.

If food has burned on, sprinkle the grid with detergent while hot and cover with wet paper towels or a dishcloth. Soaking the pan will remove burned-on foods.

Both the broiler pan and grid may be cleaned with a commercial oven cleaner.

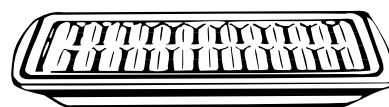

Do not store a soiled pan and grid anywhere in the oven.

Both the broiler pan and grid can also be cleaned in the dishwasher.

Do not clean the broiler pan or grid in the self-cleaning oven.

Oven Light Replacement

CAUTION: Before replacing your oven light bulb, disconnect the electrical power for your oven at the main fuse or circuit breaker panel.

Be sure to let the light cover and bulb cool completely before removing or replacing them. When in use, light bulbs can become warm enough to break if touched with a moist cloth or towel. When cleaning, avoid touching warm lights with cleaning cloths if the light cover is removed.

The oven light is covered with a removable glass cover which is held in place with a wire. Remove the oven door, if desired, to reach the cover easily.

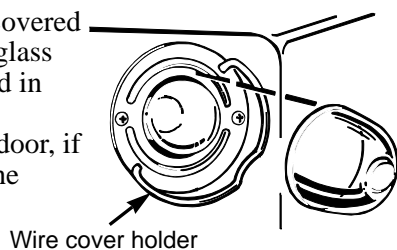

To remove:

- Hold your hand under the cover so it doesn't fall when released. With fingers of the same hand, firmly push back the wire cover holder. Lift off the cover.
- **DO NOT REMOVE ANY SCREWS.**
- Replace bulb with 40-watt home appliance bulb.

To replace cover:

- Place it into the groove of the light receptacle. Pull the wire forward to the center of cover until it snaps in place. When in place, the wire holds the cover firmly. Be certain the wire is in the depression in the center of the cover.
- Connect the electrical power to the oven.

Oven Heating Elements

Do not clean the bake element or the broil element. Any soil will burn off when the elements are heated.

The bake element can be lifted gently to clean the oven floor. If spillovers, residue or ash accumulate around the bake element gently wipe around the element with warm water.

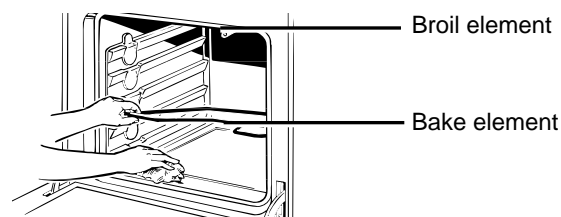

(continued next page)

CARE AND CLEANING

(continued)

Lift-Off Oven Door

The oven door is **removable**, but it is heavy. You may need help removing and replacing the door. Do not lift the door by the handle. This can cause the glass to break or can cause damage to the door.

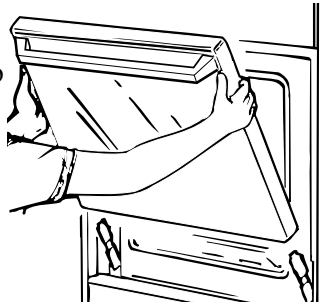

To remove the door, open it a few inches to the special stop position that will hold the door open. Grasp firmly on each side and lift the door straight up and off the hinges.

NOTE:

- Be careful not to place hands between the hinge and the oven door frame as the hinge could snap back and pinch fingers.
- While working in the oven area, cover the hinges with towels or empty paper towel rolls to prevent pinched fingers and chipping the porcelain enamel on the frame.

To replace the door, make sure the hinges are in the special stop position. Position the slots in the bottom of the door squarely over the hinges. Then lower the door slowly and evenly over both hinges at the same time. If hinges snap back against the oven frame, pull them back out.

TO CLEAN THE DOOR:

Inside of the door:

- Because the area inside the gasket is cleaned during the self-clean cycle, you do not need to clean this by hand. Any soap left on the liner causes additional stains when the oven is heated.

- The area outside the gasket can be cleaned with a soap-filled scouring pad.
- Do not rub or clean the door gasket—the fiberglass material of the gasket has an extremely low resistance to abrasion. An intact and well-fitting oven door gasket is essential for energy-efficient oven operation and good baking results. If you notice the gasket becoming worn, frayed or damaged in any way or if it has become displaced on the door, you should have it replaced.

NOTE: The gasket is designed with a gap at the bottom to allow for proper air circulation.

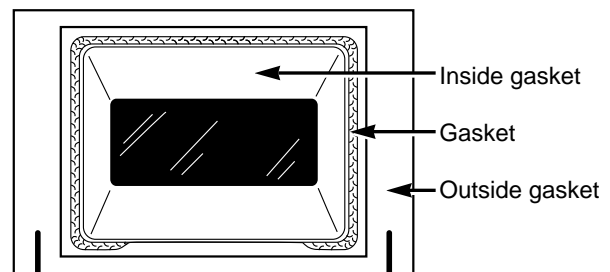

Outside of the door:

- Use soap and water to thoroughly clean the top, sides and front of the oven door. **DO NOT** let water run down through openings in the top of the door. Rinse well. You may also use a glass cleaner to clean the glass on the outside of the door.
- Spillage of marinades, fruit juices, tomato sauces and basting materials containing acids may cause discoloration and should be wiped up immediately. When surface is cool, clean and rinse.
- Do not use oven cleaners, cleansing powders or harsh abrasives on the outside of the door.

Oven Shelves

Clean the shelves with a **mild abrasive cleanser or steel wool**. After cleaning, rinse the shelves with clean water and dry with a clean cloth.

NOTE: The oven shelves may be cleaned in self-cleaning oven. However, they will darken, lose their luster and become hard to slide if cleaned during the self-cleaning cycle.

Wipe the shelf supports with cooking oil after self-cleaning to make the shelves slide more easily.

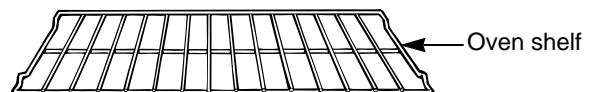

Probe

The temperature probe may be cleaned with soap and water or a soap-filled scouring pad. Cool the temperature probe before cleaning. Scour stubborn spots with a soap-filled scouring pad, rinse and dry.

**Do not immerse the temperature probe in water.
Do not store the temperature probe in the oven.**

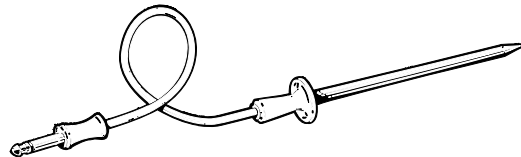

Control Panel

It's a good idea to wipe the control panel after each use of the oven. Clean with mild soap and water or vinegar and water, rinse with clean water and polish dry with a soft cloth.

Do not use abrasive cleansers, strong liquid cleaners, plastic scouring pads or oven cleansers on the control panel—they will damage the finish. A 50/50 solution of vinegar and hot water works well.

Metal Parts

Do not use steel wool, abrasives, ammonia or commercial oven cleaners. To safely clean surfaces, wash, rinse and then dry with a soft cloth.



Glass Window

To clean the outside glass of the oven window, use a glass cleaner. Rinse and polish with a dry cloth.

Do not allow the water or cleaner to run down inside openings in the glass or the openings in the top of the oven door while cleaning.

QUESTIONS? USE THIS PROBLEM SOLVER

PROBLEM	POSSIBLE CAUSE
“F-AND A NUMBER OR LETTER” FLASH IN THE DISPLAY	<ul style="list-style-type: none"> • This is a function error code. Press CLEAR/OFF. Allow the oven to cool one hour. Place the oven back into operation. • Disconnect all power to the oven for 5 minutes and then reconnect power. If the failure code repeats, call for service.
CONTROL SIGNALS AFTER ENTERING COOKING TIME OR DELAY START TIME	<ul style="list-style-type: none"> • This is reminding you to press BAKE and then enter a bake temperature. • This is reminding you to enter a bake temperature after having pressed BAKE.
DISPLAY GOES BLANK	<ul style="list-style-type: none"> • The circuit breaker in your house has been tripped, or a fuse has been blown.
DISPLAY FLASHES	<ul style="list-style-type: none"> • Power failure. Reset the clock.
UNABLE TO GET THE DISPLAY TO SHOW “SF”	<ul style="list-style-type: none"> • BAKE and BROIL HI/LO must be pressed at the same time and held for 2 seconds.
“PROBE” APPEARS IN THE DISPLAY	<ul style="list-style-type: none"> • The probe is not inserted properly into the oven receptacle or food. • This is reminding you to enter a probe temperature after plugging in the probe.
“LOCK DOOR” FLASHES	<ul style="list-style-type: none"> • Oven door not closed after self-clean cycle is selected.
“LOCKED DOOR” FLASHES	<ul style="list-style-type: none"> • Door is still locked and you are trying to enter an oven cooking operation.
OVEN LIGHT DOES NOT WORK	<ul style="list-style-type: none"> • The light bulb is loose or defective. Tighten or replace. • The pad operating the oven light is broken. Call for service.
OVEN WILL NOT SET A SELF-CLEAN CYCLE	<ul style="list-style-type: none"> • Oven temperature is too high to set self-clean operation. Allow the oven to cool to room temperature and reset the controls. • The probe is plugged into the outlet in the oven. Remove the probe from the oven.
OVEN NOT CLEAN AFTER CLEAN CYCLE	<ul style="list-style-type: none"> • Oven controls not set properly. See the Operating the Self-Cleaning Oven section. • Heavily soiled ovens require 4 to 5 hours of clean time. • Heavy spillovers should be cleaned up before starting clean cycle.
DOOR WILL NOT OPEN AFTER SELF-CLEAN CYCLE	<ul style="list-style-type: none"> • When the temperature has fallen below the locking temperature door can be opened.

PROBLEM	POSSIBLE CAUSE
OVEN WILL NOT WORK	<ul style="list-style-type: none"> • The circuit breaker in your house has been tripped, or a fuse has been blown. • The oven controls are not properly set.
FOOD DOES NOT BROIL PROPERLY	<ul style="list-style-type: none"> • Oven controls not set properly. See the Broiling section. • Door not left open to the broil stop position as recommended. • Improper shelf position being used. See the Broiling Guide. • Food is being cooked on a hot pan or on cookware not suitable for broiling. • Low voltage. See the Broiling section. • Aluminum foil used on the broiler pan and grid has not been fitted properly and slit as recommended.
FOOD DOES NOT ROAST OR BAKE PROPERLY	<ul style="list-style-type: none"> • Oven controls not set properly. See the Baking or Roasting section. • Shelf position is incorrect. See the Baking or Roasting section. • Incorrect cookware or cookware of improper size is being used. • Oven thermostat needs adjustment. See the Adjust the Oven Thermostat—<i>Do It Yourself</i> section.
OVEN TEMPERATURE TOO HOT OR TOO COLD	<ul style="list-style-type: none"> • Oven thermostat needs adjustment. See the Adjust the Oven Thermostat—<i>Do It Yourself</i> section.
“BURNING” OR “OILY” ODOR EMITTING FROM OVEN WHEN TURNED ON	<ul style="list-style-type: none"> • This is normal in a new oven and will disappear in time. To speed the process, set a self-clean cycle for a minimum of 3 hours. See the Operating the Self-Cleaning Oven section.
STRONG ODOR	<ul style="list-style-type: none"> • An odor from the insulation around the inside of the oven is normal for the first few times the oven is used. This is temporary.
FAN NOISE	<ul style="list-style-type: none"> • A cooling fan may automatically turn on and off to cool internal parts. This is normal and the fan may continue to run even after the oven is off.

If you need more help...call, toll free:
GE Answer Center®
800.626.2000
consumer information service

YOUR MONOGRAM ELECTRIC OVEN WARRANTY

Staple sales slip or cancelled check here. Proof of original purchase date is needed to obtain service under warranty.

WHAT IS COVERED

FULL ONE-YEAR WARRANTY

For one year from date of original purchase, we will provide, free of charge, parts and service labor in your home to repair or replace **any part of the oven** that fails because of a manufacturing defect.

This warranty is extended to the original purchaser and any succeeding owner for products purchased for ordinary home use in the 48 mainland states, Hawaii and Washington, D.C. In Alaska the warranty is the same except that it is LIMITED because you must pay to ship the product to the service shop or for the service technician's travel costs to your home.

All warranty service will be provided by our Factory Service Centers or by our authorized Customer Care® servicers during normal working hours.

Should your appliance need service, during warranty period or beyond, call 800-GE-CARES (800-432-2737).

WHAT IS NOT COVERED

- Service trips to your home to teach you how to use the product.

Read your Use and Care material. If you then have any questions about operating the product, please contact your dealer or our Consumer Affairs office at the address below, or call, toll free:

GE Answer Center®
800.626.2000
consumer information service

- Improper installation.

If you have an installation problem, contact your dealer or installer. You are responsible for providing adequate electrical, gas, exhausting and other connecting facilities as described in the Installation Instructions provided with the product.

- Replacement of house fuses or resetting of circuit breakers.
- Failure of the product if it is used for other than its intended purpose or used commercially.
- Damage to product caused by accident, fire, floods or acts of God.

WARRANTOR IS NOT RESPONSIBLE FOR CONSEQUENTIAL DAMAGES.

Some states do not allow the exclusion or limitation of incidental or consequential damages, so the above limitation or exclusion may not apply to you. This warranty gives you specific legal rights, and you may also have other rights which vary from state to state. To know what your legal rights are in your state, consult your local or state consumer affairs office or your state's Attorney General.

Warrantor: General Electric Company

**If further help is needed concerning this warranty, write:
Manager—Consumer Affairs, GE Appliances, Louisville, KY 40225**



Monogram™

General Electric Company
Louisville, KY 40225

Pub. No. 49-8758
Part No. 164D3333P017
5-96 CG

Printed in LaFayette, GA